



Tecumseh

GUIDELINES FOR USING R-452A AND R-448A/R-449A

Guidelines for using R448A/R449A and R452A in new and existing
commercial refrigeration

www.tecumseh.com

Guidelines for using R-452A and R-448A/R-449A in new and existing commercial refrigeration systems

Guidelines for using R-452A and R-448A/R-449A in new and existing commercial refrigeration systems

1. R-452A and R-448A/R-449A refrigerants context

Tecumseh Products Company does not recommend the retrofit of existing refrigeration systems that are operating leak free. If the system is not leaking refrigerant to the atmosphere, and is operating properly, there is no reason to replace the refrigerant. Please check with the equipment manufacturer, as changing the refrigerant may void the safety certification.

This guideline aims to provide practical information and recommendations for using R-452A and R-448A/R-449A in new and existing low, medium and high temperature commercial refrigeration systems. These recommendations are applicable to all Tecumseh hermetic reciprocating and rotary compressors (includes Tecumseh condensing units), with the exception of Masterflux® ranges. R-452A and R-448A/R-449A should only be used in Tecumseh compressors approved for these refrigerants.

R-452A and R-448A/R-449A are not direct drop-in replacements for R-404A/R-507. The capacity and efficiency will somewhat vary and there are differences that must be considered when handling, processing, applying or retrofitting refrigerants.

Unlike R-452A, refrigerants R-448A and R-449A have higher discharge temperatures than R-404A (10 to 30K; 18 to 54F) particularly at lower evaporating temperatures. Therefore, special precautions must be taken to ensure reliable compressor operation.

2. Environmental Data

R-452A and R-448A/R-449A are mixtures of common hydrofluorocarbons (HFC) and new hydrofluoro-olefin molecule R-1234yf (HFO), with composition changes detailed below.

| | R-507 | R-404A | R-449A | R-448A | R-452A |
|----------|-------|--------|--------|--------|--------|
| R-143a | 50% | 52% | 0% | | 0% |
| R-32 | 0% | 0% | 24% | 26% | 11% |
| R-125 | 50% | 44% | 25% | 26% | 59% |
| R-134a | 0% | 4% | 26% | 21% | 0% |
| R-1234yf | 0% | 0% | 25% | 20% | 30% |
| R-1234ze | | | | 7% | |

R-452A and R-448A/R-449A are all non-flammable. They have been assigned an A1 safety classification under ASHRAE 34 and EN 378 standards. A1 means that the substance is classified “non- dangerous” with the following nomenclature:

A = Low toxicity

1 = No flame propagation at 18°C / 64.4°F, 101300 Pa / 14.7 PSI.

However, because R-452A and R-448A/R-449A contain mildly flammable components R-32 and R-1234yf, they should not be mixed with air to check for system leaks as these mixtures can become combustible.

Guidelines for using R-452A and R-448A/R-449A in new and existing commercial refrigeration systems

Other physical properties are shown in the following table.

| Refrigerant Properties | R-404A | R-448A/ R-449A | R-452A |
|---|---------------|-------------------|--------------|
| Boiling point at 1 bar (°C / °F) | -46.5 / -51.7 | -46 / -50.8 | -47 / -52.6 |
| Critical temperature (°C / °F) | 72.1 / 161.8 | 80.1 / 176.2 | 74.9 / 166.8 |
| Critical pressure (bar abs / PSIG) | 37.3 / 541 | 44.1 / 639.6 | 40.0 / 580.2 |
| Liquid density at 32°C / 90°F (kg/m ³) | 1010 | 1061 | 1093 |
| Vapor density at -30°C / -22°F (kg/m ³) | 10.7 | 7.3 | 10.1 |

Chlorine is not present in R-452A and R-448A/R-449A and consequently, these refrigerants have zero Ozone Depletion Potential (ODP). Their Global Warming Potential is 45% and 64% respectively lower than R-404A.

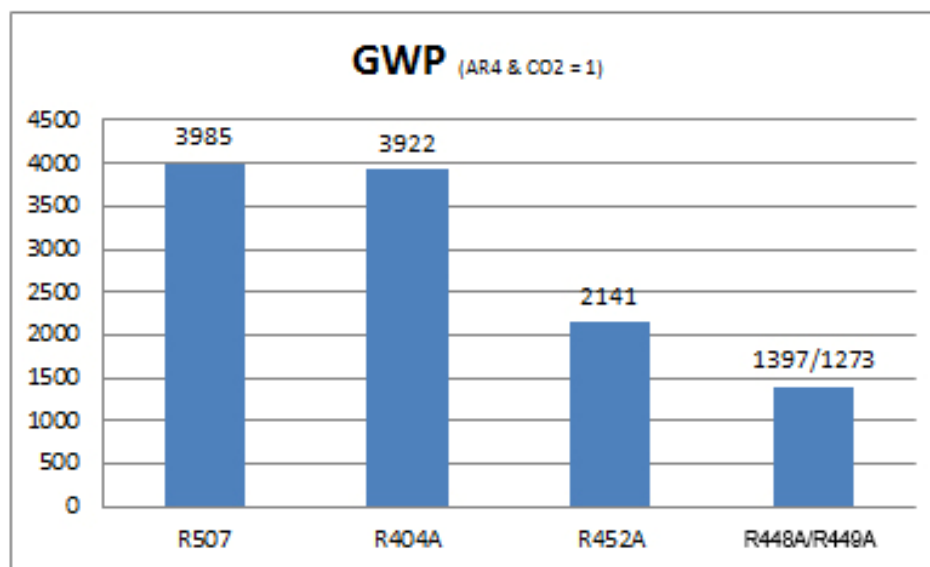

3. Refrigerant Properties

Glide and heat exchanger performance

R-404A is a quasi-azeotrope refrigerant blend, which means it condenses and boils at nearly the same temperature for a given pressure (temperature glide lower than 0.5K).

On the other hand, refrigerants R-452A and R-448A/R-449A exhibit 1.5 to 5K (2.7 to 9.0F) of temperature glide, depending on the operating conditions (see following table).

Guidelines for using R-452A and R-448A/R-449A in new and existing commercial refrigeration systems

| Fluid \ T _{dew} | Effective Temperature Glide (K / F) | | | |
|--------------------------|-------------------------------------|--------------|------------|--------------|
| | Evaporator | | | Condenser |
| | -35°C / -31°F | -10°C / 14°F | 0°C / 32°F | 45°C / 113°F |
| R-404A | 0.3 / 0.54 | 0.3 / 0.54 | 0.4 / 0.72 | 0.3 / 0.54 |
| R-448A/R-449A | 3.0 / 5.4 | 3.5 / 6.3 | 3.8 / 6.8 | 4.5 / 8.1 |
| R-452A | 1.7 / 3.1 | 2.2 / 4.0 | 2.5 / 4.5 | 3.5 / 6.3 |

Effective glide takes into account the real inlet evaporator temperature

Temperature will increase during the evaporation phase and decrease during the condensation phase. Counter flow heat exchanger technology that has been utilized over the last 10 years will be less sensitive to this physical phenomenon vs. parallel flow.

Also, average temperature during the evaporating phase, named “mid” temperature, increases the temperature difference (TD) between the primary and secondary fluids, compared to the dew temperature reference.

- These two (2) facts may counteract possible heat exchanger capacity losses.
- One remaining risk is ice-up of the evaporator which is dependent upon the secondary fluid type and the amount of flow across the heat exchangers.
 - The defrost control’s time (frequency and duration) and temperature settings could be adjusted and/or reset to reduce the risk of ice build-up.

The corresponding Pressure-Temperature of refrigerants R-452A and R-448A/R-449A vs. R-404A, including bubble and dew point data, is shown in the tables on pages 14 to 16. In order to properly feed the expansion device and to reach the expected capacity delivered by the evaporator, the technician should check to determine if there is sufficient sub cooling at the condenser outlet. The amount of sub cooling can be determined by referencing the bubble temperature column. In order to determine the amount of superheat, refer to the column denoted “dew temperature.”

R-452A saturated pressures are marginally lower than refrigerant R-404A; R-448A/R-449A pressures are slightly lower than R-404A.

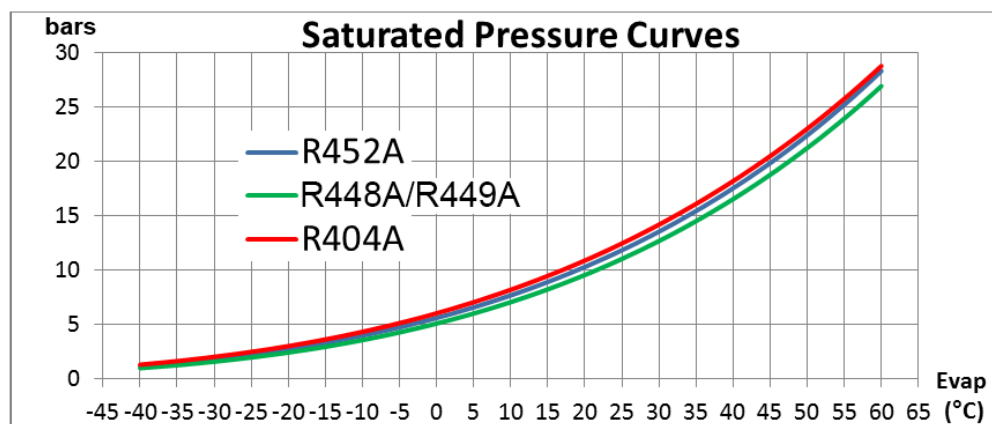

Guidelines for using R-452A and R-448A/R-449A in new and existing commercial refrigeration systems

Rating conditions & displayed performances according to reference standard

Compressor standards use dew point temperatures because they allow for a clear correlation between pressures and temperatures. For purpose of analysis, a mean temperature may be used to represent the actual system performance or for comparing blends with pure refrigerants.

The average condensing temperature is the arithmetic mean of dew and bubble temperatures at the condensing pressure and can be easily calculated. However, the average evaporating temperature is the mean between the dew temperature at the evaporating pressure and the temperature at the evaporator inlet which depends on the condensing pressure and the extent of sub cooling. Please refer to the *ASERCOM* glide [guideline](#) for further details and a method to convert dew point to mid-point temperature.

4. Medium Temperature Performance

Testing performed by Tecumseh shows refrigerant behaviors based on various evaporating and condensing pressures. These results may vary slightly depending on the compressors platforms.

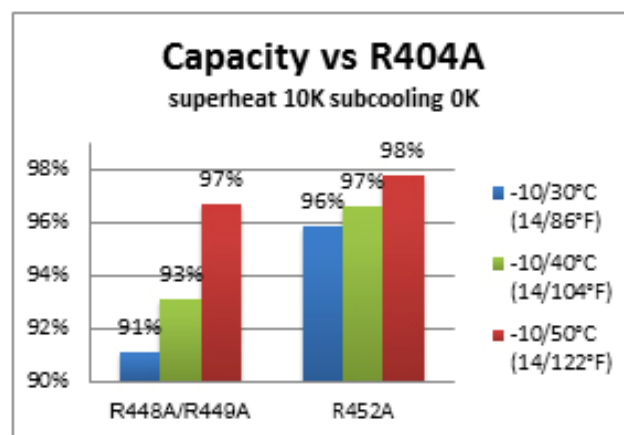

R-452A delivers more capacity than R-448A/R-449A especially at low condensing temperatures.

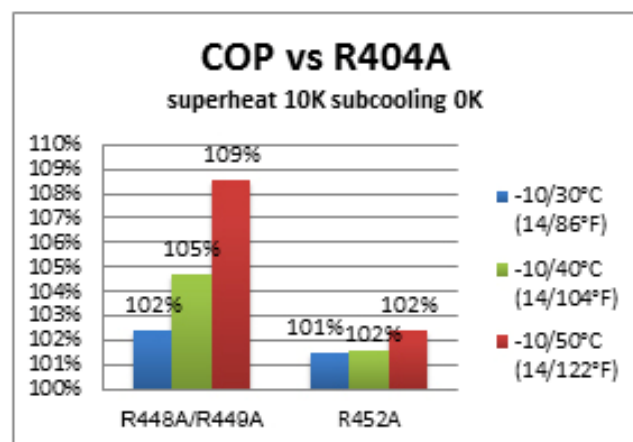

Refrigerants R-452A and R-448A/R-449A exhibit an efficiency gain over R-404A, with a slight advantage for R-448A/R-449A. This is especially true at high evaporating and condensing temperatures.

Guidelines for using R-452A and R-448A/R-449A in new and existing commercial refrigeration systems

5. Low Temperature Performance

Results below may vary slightly depending on the compressor platform.

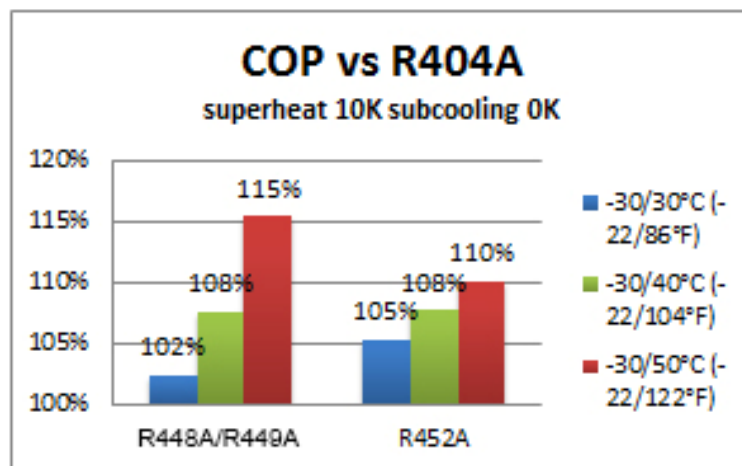
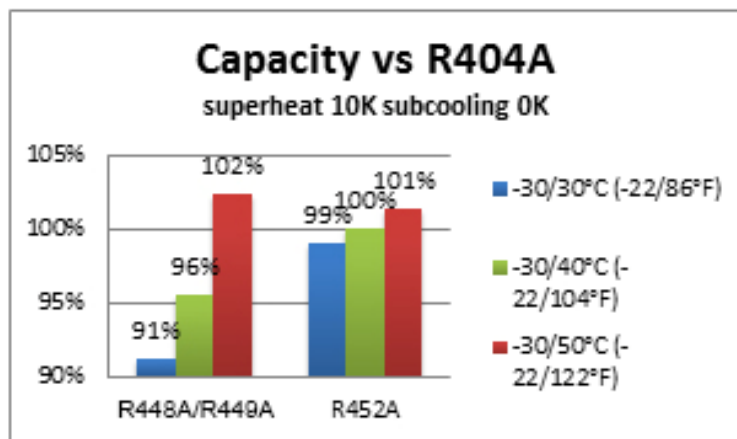

Guidelines for using R-452A and R-448A/R-449A in new and existing commercial refrigeration systems

6. Compressor Reliability

Compatibility

Extensive testing has been conducted in determining that refrigerants R-452A and R-448A/R-449A are compatible with the polyol ester (POE) and polyvinyl ether (PVE) lubricants already approved by Tecumseh and with all materials used in Tecumseh R-404A compressors and condensing units. Contact your Tecumseh sales representative for the latest list of approved oils.

Chemical Stability

Stability tests indicate that R-452A and R-448A/R-449A low GWP molecules tend to decompose more easily than R-404A when in the presence of air and, this is accentuated by the presence of water.

When decomposed, refrigerants generate fluoride ions and organic acids, causing POE oil degradation (PVE is less a concern), corrosion of expansion valves, plugging of capillary tubes, and wearing of sliding parts.

Moisture

Chemical stability of refrigerant oil requires an extremely low system moisture content. Failure to comply with this requirement will result in the formation of decomposition products.

- POE and PVE oils are 100 times more hygroscopic (ability to absorb moisture) than mineral oils. This moisture is difficult to remove from the oil even when heat is applied and/or a vacuum is pulled on the system.
- **Utmost care must be taken to prevent moisture from getting into the refrigeration system.** Do not leave the compressor or system open to the atmosphere for longer than a maximum of 10 minutes. The preferred method of assembly is to remove system component plugs and caps just prior to brazing. The maximum system moisture content after completing system processing should be 80 PPM. After running the system with the appropriate filter-drier installed, the system moisture level should be less than or equal to 50 PPM. These levels are based on measuring the moisture in liquid refrigerant samples taken from the system.
- **Contact the filter-drier manufacturer** for recommendations on appropriate filter drier selection.

If there are questions about the lubricant, or tests indicate it is contaminated or has a high acid number, then the lubricant must be changed. Six (6) months after a retrofit, the oil should be tested again.

Guidelines for using R-452A and R-448A/R-449A in new and existing commercial refrigeration systems

Viscosity

Thanks to the R-404A-like dynamic viscosity of the POE32 oil / R-452A mixture, the Minimum Oil Film Thickness (MOFT) expected with the R-452A is very close or even higher than the one obtained with R-404A, which will prevent wear and failure.

Due to the higher working temperature with R-448A/R-449A that reduces the oil viscosity and consequently the MOFT, Tecumseh advises to replace standard lubricant viscosity grade 32 cSt by viscosity grade 68 when running steadily at high condensing temperatures. That will bring up the MOFT to R-404A levels.

Dynamic Viscosity Refrigerant/Oil

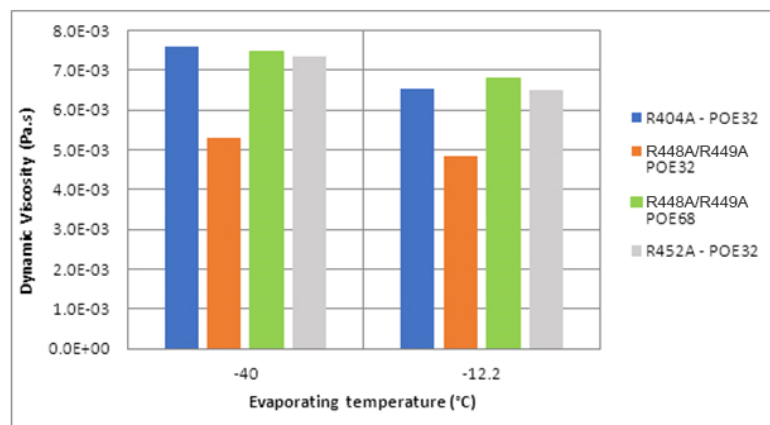

Lubricant manufacturers are still evaluating the effects of R-404A replacements in current lubricants to see whether there are opportunities to improve solubility and energy efficiency, and may eventually release optimized lubricants. Tecumseh is continuing to test compressors with the compatibility of oil, refrigerant, and materials in mind.

Thermal Stability

The exposure of lubricants to high temperatures over long periods of time can lead to the formation of decomposition products. This decomposition is accelerated in the presence of contaminants such as air or water. The process will occur in a shorter period of time if there have been several 10K increases in temperature. As the system approaches the appropriate line, the chances of coking increase (overheated lubricant becomes carbonized at the compressor valve plate, causing the valve to leak and elevating the temperature even higher). Ultimately, breakdown of the oil and carbonized deposits will cause loss of lubrication and metal-to-metal contact that results in seizure of the compressor's pumping mechanism.

With respect to refrigerant **R-452A**, the high percentage of R-125 lowers the discharge temperature to R-404A levels. As such, R-452A can be used as a near drop-in replacement for R-404A in medium and low temperature applications. R-452A is particularly suitable for:

- Refrigeration applications that operate over a wide range of ambient temperatures
- Low temperature applications where limited superheat or condensing temperature are not practical
- Static cooling applications

Guidelines for using R-452A and R-448A/R-449A in new and existing commercial refrigeration systems

- Applications that require a heat exchanger between the liquid and suction lines. R-452A has a mass flow rate similar to R-404A and benefits from a relatively high superheating enthalpy

R-448A/R-449A have a higher isentropic exponent due to the high percentage content of refrigerant R-32 and at same running conditions to R-404A, discharge gas and motor temperature will increase by 15K to 30K (27F to 54F), particularly at low evaporating temperatures.

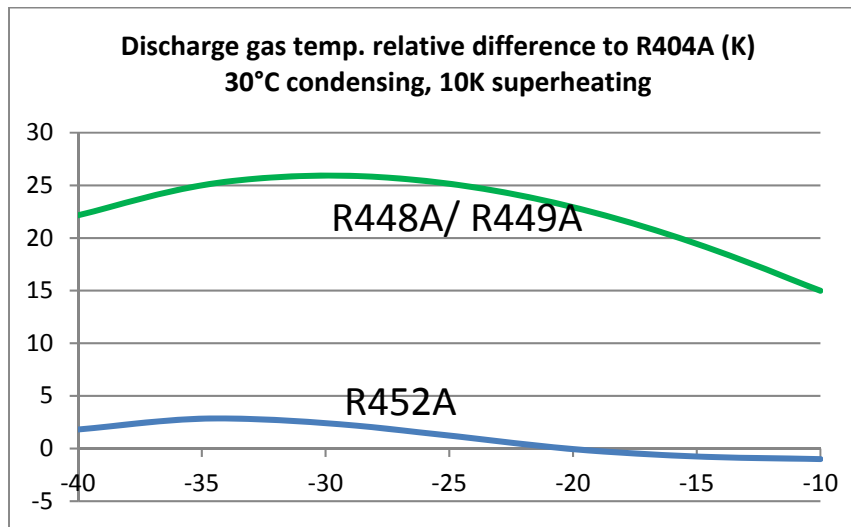

The temperature difference between the discharge line and compressor valve plate when using R-448A/R-449A can exceed 55K (100°F).

NOTE: One or more of the recommendations outlined below must be implemented in order to maintain compressor discharge temperatures within their operating limits.

Compressor Cooling

Tecumseh requires that discharge gas temperatures are maintained below 125°C (257°F) for multi-cylinder and below 120°C (248°F) for single cylinder compressors with an evaporating temperature of -30°C (-22°F) and below.

- For any application, we highly recommend sufficient compressor fan cooling especially at Low operating temperatures.
- Specific to refrigerants R-448A/R-449A:
 - Do NOT insulate the compressor with a sound blanket and/or other means as it will result in elevated discharge temperatures
 - Limit return gas superheat to a maximum of 10°K / 18°F or less at the LBP compressor's suction inlet.
 - Do NOT apply liquid/vapor heat exchangers (commonly known as desuperheaters) as it will result in elevated discharge temperatures.
 - In order to prevent plugging issues, capillary tubes must not be used for LBP compressors. Tecumseh preconizes to use a thermostatic expansion valve

Guidelines for using R-452A and R-448A/R-449A in new and existing commercial refrigeration systems

- Special care must be taken with applications using a hot gas bypass valve or a constant evaporating pressure valve (e.g., refrigerated air dryers and multi-evaporators fed by a same condensing unit).
- Select the appropriate refrigerant to be able to maintain the discharge gas temperature below 120°C (248°F).
- Regular inspection and cleaning of the condenser coil is required in order to maintain compressor operating temperatures within published specifications.
- Compressor discharge gas temperature must be measured prior to performing a system refrigerant retrofit to be able to check whether the difference in temperature measured with the new refrigerant is realistic.
- When superheating cannot be maintained under 10K / 18°F (e.g., remote condensing units), a temperature responsive expansion valve (e.g., Parker TREV Y1037) that monitors the discharge temperature via a sensing bulb, shall be used. Injecting a mixture of saturated liquid and vapor into the suction line will reduce the temperature of the superheated suction vapor and in turn, reduce excessive discharge temperatures. Consult with the expansion device manufacturer for correct valve sizing, installation location and temperature adjustments. NOTE: If liquid refrigerant enters the compressor, it may damage compressor bearings.

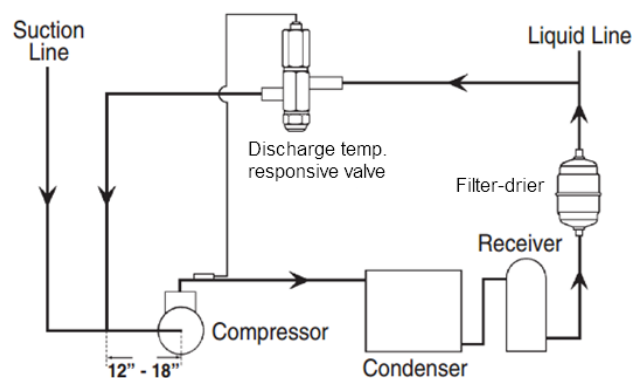

In conjunction with the TREV, a properly sized suction line accumulator may be installed adjacent the compressor.

Compressor Operating Window

The operating windows shown below are provided as guidelines only and need to be adjusted based on the specific compressor model involved and the overall design of the refrigeration system. In general terms, limiting superheat to a maximum temperature of 10K (18F), the operating window defined for R-404A Low Temperature system is fully or mostly usable with refrigerants R-452A and R-448A/R-449A.

Guidelines for using R-452A and R-448A/R-449A in new and existing commercial refrigeration systems

Please refer to the “Compressor Cooling” section on Page 9 and follow the steps to maintain discharge temperatures within operating limits. Tecumseh requires that compressor discharge gas temperatures be measured and that the necessary steps be taken to maintain temperatures below 125°C (257°F) for multi-cylinder and below 120°C (248°F) for single cylinder compressors with an evaporating temperature of -30°C (-22°F) and below.

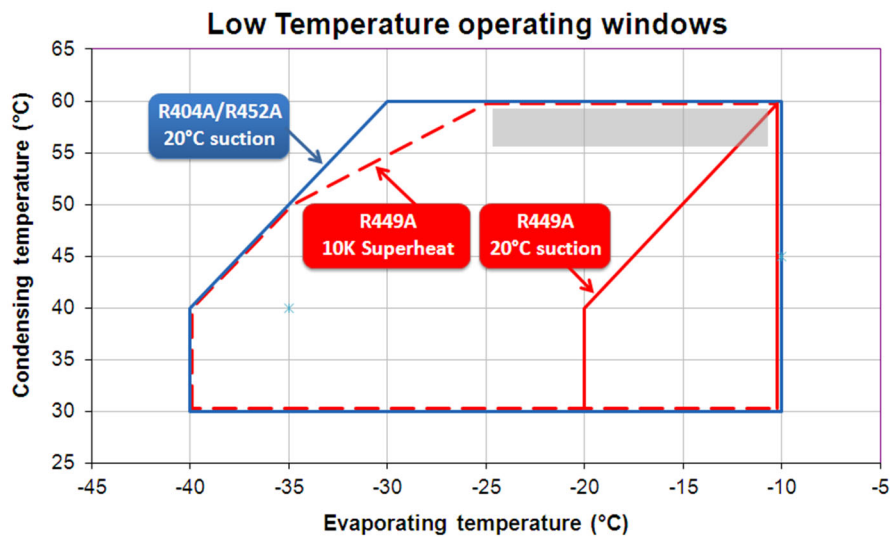

In cases where refrigerating systems using a reciprocating compressor would run at steady conditions into the shaded area of the above compressor application window, then Tecumseh advises to replace the current POE 32cst oil viscosity grade by a 68cst.

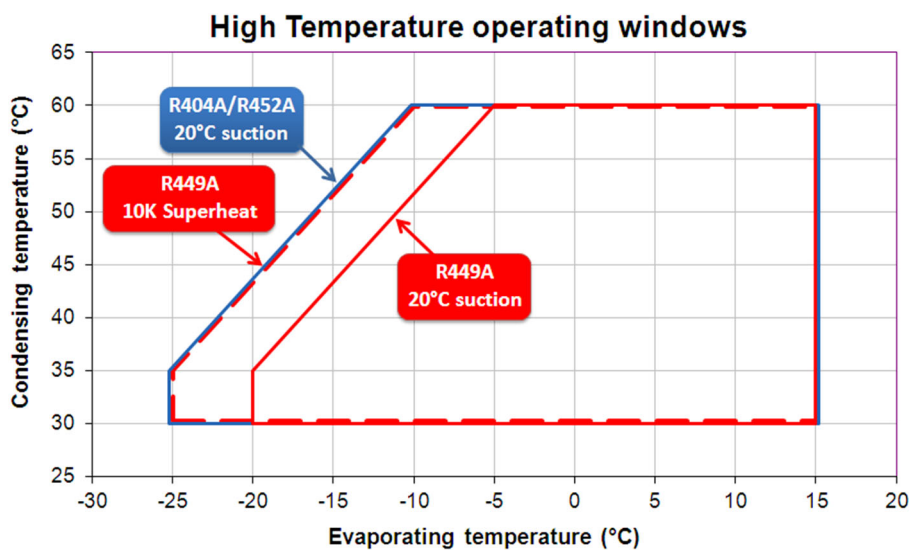

Guidelines for using R-452A and R-448A/R-449A in new and existing commercial refrigeration systems

7. Application Side

Refrigerant Charge

Refrigerant blends R-452A and R-448A/R-449A are azeotrope and must be charged in the liquid state. The refrigerant cylinder should be equipped with a dip tube, thereby eliminating the need to turn the cylinder upside down.

The use of a scale is recommended when charging the system. Initial refrigerant should be charged into the receiver tank or liquid line.

Tecumseh recommends the use of a refrigerant charging system with an in-line sight glass liquid refrigerant can be seen.

- To prevent compressor damage, do not charge liquid into the suction line.
- R-452A and R-448A/R-449A should not be mixed with any other refrigerant.
- Pre-charge installation recommended at 80% of initial amount into liquid receiver.
- Final R-452A and R-448A/R-449A refrigerant mass will be 5% to 10% higher compared to R-404A.

Liquid Density (for reference only)

| Temperature | R404A | R448A-R449A | R452A | R448A-R449A /R404A-1 | R452A/R404A- 1 |
|-----------------|-------------------|-------------------|-------------------|-------------------------|-------------------|
| °C / °F | kg/m ³ | kg/m ³ | kg/m ³ | % | |
| -20 / -4 | 1223.1 | 1265.4 | 1318.2 | 3.5% | 7.8% |
| -10 / 14 | 1188.0 | 1232.3 | 1280.8 | 3.7% | 7.8% |
| 40 / 104 | 966.1 | 1019.8 | 1047.2 | 5.6% | 8.4% |
| 60 / 140 | 815.8 | 893.7 | 896.9 | 9.5% | 9.9% |

Please refer to the Dew point saturated pressures to measure superheat and to the Bubble point saturated pressures to measure sub cooling.

Expansion Device Setting

Do not use capillary tube as an expansion device with R-448A/R-449A.

With R-452A, capillary tube can be used for Medium and High Back pressure compressors.

R-452A has a similar mass flow rate to R-404A so, Thermostatic Expansion Valve (TXV) settings may be retained with minor adjustments.

R-448A/R-449A have a lower mass flow rate (-20% to -25%) in comparison to R-404A and, combined with differences in temperature glide and capacity, a new properly sized expansion device should be installed. Consult with the expansion device manufacturer for correct valve sizing and superheat adjustments.

Guidelines for using R-452A and R-448A/R-449A in new and existing commercial refrigeration systems

Condensing Pressure Deviation expected after a Retrofit

Expected saturated condensing temperatures will be within 2K (3.6°F) for R-452A and R-448A/R-449A when compared to systems operating with R-404A at comparable Midpoint evaporating pressures.

Pressure Control Settings

R-452A and R-448A/R-449A saturated pressures are slightly lower than R-404A. Therefore, Low Pressure and High Pressure control settings must be adjusted so that system operating pressures do NOT exceed the compressor's operating window (see page 11). The maximum allowed saturated discharge pressure equals 60°C (140°F). Refer to pressure chart.

Compression Ratio Comparison at Dew Point Rating Conditions

| Evap (°C / °F) | Cond (°C / °F) | R404A | R452A | R448A/R449A |
|------------------|-----------------|-------|-------|-------------|
| -35 / -31 | 40 / 104 | 11.0 | 11.8 | 12.9 |
| -25 / -13 | 45 / 113 | 8.2 | 8.8 | 9.4 |
| -10 / 14 | 45 / 113 | 4.7 | 5.0 | 5.2 |
| 5 / 41 | 55 / 131 | 3.6 | 3.8 | 4.0 |
| 15 / 59 | 60 / 140 | 3.0 | 3.2 | 3.3 |

Expected Sound Level

Acoustic power deviation of compressors running with R-452A and R-448A/R-449A will remain within +/- 2 dBA of R-404A.

Guidelines for using R-452A and R-448A/R-449A in new and existing commercial refrigeration systems

Pressure/Temperature

| Temperature | | Pressure | | | | | | | | | |
|-------------|-------|--------------------|-----------------------|---------------------|------------------------|--------------------|-----------------------|---------------------|------------------------|--------------------|---------------------|
| °C | °F | R452A | | | | R448A/R449A | | | | R404A | |
| | | bar _{dew} | bar _{bubble} | psig _{dew} | psig _{bubble} | bar _{dew} | bar _{bubble} | psig _{dew} | psig _{bubble} | bar _{dew} | psig _{dew} |
| -45 | -49 | 0.93 | 1.12 | 13.47 | 16.20 | 0.78 | 1.06 | 11.36 | 15.35 | 1.05 | 15.25 |
| -44 | -47.2 | 0.98 | 1.17 | 14.15 | 16.98 | 0.82 | 1.11 | 11.96 | 16.10 | 1.10 | 15.99 |
| -43 | -45.4 | 1.02 | 1.23 | 14.85 | 17.80 | 0.87 | 1.16 | 12.58 | 16.88 | 1.16 | 16.76 |
| -42 | -43.6 | 1.07 | 1.29 | 15.57 | 18.65 | 0.91 | 1.22 | 13.22 | 17.68 | 1.21 | 17.56 |
| -41 | -41.8 | 1.13 | 1.35 | 16.33 | 19.52 | 0.96 | 1.28 | 13.90 | 18.52 | 1.27 | 18.39 |
| -40 | -40 | 1.18 | 1.41 | 17.11 | 20.43 | 1.01 | 1.34 | 14.59 | 19.39 | 1.33 | 19.25 |
| -39 | -38.2 | 1.24 | 1.47 | 17.93 | 21.38 | 1.06 | 1.40 | 15.32 | 20.29 | 1.39 | 20.14 |
| -38 | -36.4 | 1.29 | 1.54 | 18.77 | 22.35 | 1.11 | 1.46 | 16.08 | 21.22 | 1.45 | 21.06 |
| -37 | -34.6 | 1.35 | 1.61 | 19.64 | 23.36 | 1.16 | 1.53 | 16.86 | 22.18 | 1.52 | 22.01 |
| -36 | -32.8 | 1.42 | 1.68 | 20.55 | 24.41 | 1.22 | 1.60 | 17.67 | 23.18 | 1.59 | 23.00 |
| -35 | -31 | 1.48 | 1.76 | 21.49 | 25.49 | 1.28 | 1.67 | 18.52 | 24.22 | 1.66 | 24.02 |
| -34 | -29.2 | 1.55 | 1.83 | 22.46 | 26.61 | 1.34 | 1.74 | 19.39 | 25.29 | 1.73 | 25.07 |
| -33 | -27.4 | 1.62 | 1.91 | 23.46 | 27.76 | 1.40 | 1.82 | 20.30 | 26.39 | 1.80 | 26.16 |
| -32 | -25.6 | 1.69 | 2.00 | 24.50 | 28.96 | 1.46 | 1.90 | 21.24 | 27.53 | 1.88 | 27.29 |
| -31 | -23.8 | 1.76 | 2.08 | 25.58 | 30.19 | 1.53 | 1.98 | 22.21 | 28.72 | 1.96 | 28.45 |
| -30 | -22 | 1.84 | 2.17 | 26.69 | 31.47 | 1.60 | 2.06 | 23.22 | 29.94 | 2.04 | 29.66 |
| -29 | -20.2 | 1.92 | 2.26 | 27.84 | 32.78 | 1.67 | 2.15 | 24.26 | 31.20 | 2.13 | 30.90 |
| -28 | -18.4 | 2.00 | 2.35 | 29.03 | 34.14 | 1.75 | 2.24 | 25.34 | 32.50 | 2.22 | 32.18 |
| -27 | -16.6 | 2.09 | 2.45 | 30.25 | 35.54 | 1.82 | 2.33 | 26.46 | 33.84 | 2.31 | 33.50 |
| -26 | -14.8 | 2.17 | 2.55 | 31.52 | 36.98 | 1.90 | 2.43 | 27.62 | 35.22 | 2.40 | 34.86 |
| -25 | -13 | 2.26 | 2.65 | 32.83 | 38.47 | 1.99 | 2.53 | 28.81 | 36.65 | 2.50 | 36.27 |
| -24 | -11.2 | 2.36 | 2.76 | 34.17 | 40.00 | 2.07 | 2.63 | 30.04 | 38.12 | 2.60 | 37.71 |
| -23 | -9.4 | 2.45 | 2.87 | 35.56 | 41.58 | 2.16 | 2.73 | 31.32 | 39.64 | 2.70 | 39.21 |
| -22 | -7.6 | 2.55 | 2.98 | 37.00 | 43.21 | 2.25 | 2.84 | 32.63 | 41.20 | 2.81 | 40.74 |
| -21 | -5.8 | 2.65 | 3.09 | 38.48 | 44.89 | 2.34 | 2.95 | 33.99 | 42.81 | 2.92 | 42.32 |
| -20 | -4 | 2.76 | 3.21 | 40.00 | 46.61 | 2.44 | 3.07 | 35.39 | 44.47 | 3.03 | 43.95 |
| -19 | -2.2 | 2.87 | 3.34 | 41.57 | 48.39 | 2.54 | 3.18 | 36.83 | 46.17 | 3.15 | 45.63 |
| -18 | -0.4 | 2.98 | 3.46 | 43.18 | 50.21 | 2.64 | 3.30 | 38.33 | 47.93 | 3.26 | 47.35 |
| -17 | 1.4 | 3.09 | 3.59 | 44.85 | 52.09 | 2.75 | 3.43 | 39.86 | 49.73 | 3.39 | 49.12 |
| -16 | 3.2 | 3.21 | 3.72 | 46.56 | 54.02 | 2.86 | 3.56 | 41.45 | 51.59 | 3.51 | 50.94 |
| -15 | 5 | 3.33 | 3.86 | 48.32 | 56.01 | 2.97 | 3.69 | 43.08 | 53.50 | 3.64 | 52.82 |
| -14 | 6.8 | 3.46 | 4.00 | 50.13 | 58.05 | 3.09 | 3.82 | 44.76 | 55.46 | 3.77 | 54.74 |
| -13 | 8.6 | 3.59 | 4.15 | 52.00 | 60.14 | 3.21 | 3.96 | 46.49 | 57.48 | 3.91 | 56.72 |
| -12 | 10.4 | 3.72 | 4.30 | 53.92 | 62.29 | 3.33 | 4.11 | 48.27 | 59.55 | 4.05 | 58.75 |
| -11 | 12.2 | 3.85 | 4.45 | 55.89 | 64.50 | 3.45 | 4.25 | 50.10 | 61.68 | 4.19 | 60.84 |
| -10 | 14 | 3.99 | 4.60 | 57.91 | 66.77 | 3.58 | 4.40 | 51.99 | 63.86 | 4.34 | 62.98 |
| -9 | 15.8 | 4.14 | 4.76 | 59.99 | 69.10 | 3.72 | 4.56 | 53.93 | 66.11 | 4.49 | 65.18 |
| -8 | 17.6 | 4.28 | 4.93 | 62.13 | 71.49 | 3.86 | 4.72 | 55.92 | 68.41 | 4.65 | 67.43 |
| -7 | 19.4 | 4.44 | 5.10 | 64.33 | 73.94 | 4.00 | 4.88 | 57.97 | 70.77 | 4.81 | 69.75 |
| -6 | 21.2 | 4.59 | 5.27 | 66.58 | 76.45 | 4.14 | 5.05 | 60.08 | 73.20 | 4.97 | 72.12 |

Guidelines for using R-452A and R-448A/R-449A in new and existing commercial refrigeration systems

| Temperature | | Pressure | | | | | | | | | |
|-------------|------|--------------------|-----------------------|---------------------|------------------------|--------------------|-----------------------|---------------------|------------------------|--------------------|---------------------|
| °C | °F | R452A | | | | R448A/R449A | | | | R404A | |
| | | bar _{dew} | bar _{bubble} | psig _{dew} | psig _{bubble} | bar _{dew} | bar _{bubble} | psig _{dew} | psig _{bubble} | bar _{dew} | psig _{dew} |
| -5 | 23 | 4.75 | 5.45 | 68.89 | 79.03 | 4.29 | 5.22 | 62.25 | 75.68 | 5.14 | 74.55 |
| -4 | 24.8 | 4.91 | 5.63 | 71.27 | 81.67 | 4.45 | 5.39 | 64.48 | 78.23 | 5.31 | 77.05 |
| -3 | 26.6 | 5.08 | 5.82 | 73.70 | 84.38 | 4.60 | 5.57 | 66.76 | 80.84 | 5.49 | 79.60 |
| -2 | 28.4 | 5.25 | 6.01 | 76.20 | 87.15 | 4.76 | 5.76 | 69.11 | 83.52 | 5.67 | 82.22 |
| -1 | 30.2 | 5.43 | 6.20 | 78.76 | 89.99 | 4.93 | 5.95 | 71.52 | 86.27 | 5.85 | 84.91 |
| 0 | 32 | 5.61 | 6.41 | 81.39 | 92.90 | 5.10 | 6.14 | 73.99 | 89.08 | 6.04 | 87.65 |
| 1 | 33.8 | 5.80 | 6.61 | 84.08 | 95.88 | 5.28 | 6.34 | 76.53 | 91.96 | 6.24 | 90.47 |
| 2 | 35.6 | 5.99 | 6.82 | 86.85 | 98.93 | 5.46 | 6.54 | 79.14 | 94.90 | 6.44 | 93.35 |
| 3 | 37.4 | 6.18 | 7.04 | 89.67 | 102.05 | 5.64 | 6.75 | 81.81 | 97.92 | 6.64 | 96.30 |
| 4 | 39.2 | 6.38 | 7.26 | 92.57 | 105.24 | 5.83 | 6.96 | 84.55 | 101.01 | 6.85 | 99.32 |
| 5 | 41 | 6.59 | 7.48 | 95.54 | 108.51 | 6.02 | 7.18 | 87.35 | 104.17 | 7.06 | 102.41 |
| 6 | 42.8 | 6.80 | 7.71 | 98.58 | 111.86 | 6.22 | 7.41 | 90.23 | 107.41 | 7.28 | 105.57 |
| 7 | 44.6 | 7.01 | 7.95 | 101.70 | 115.27 | 6.42 | 7.63 | 93.19 | 110.72 | 7.50 | 108.80 |
| 8 | 46.4 | 7.23 | 8.19 | 104.88 | 118.77 | 6.63 | 7.87 | 96.21 | 114.10 | 7.73 | 112.11 |
| 9 | 48.2 | 7.46 | 8.44 | 108.15 | 122.34 | 6.85 | 8.11 | 99.31 | 117.57 | 7.96 | 115.49 |
| 10 | 50 | 7.69 | 8.69 | 111.49 | 126.00 | 7.07 | 8.35 | 102.48 | 121.11 | 8.20 | 118.94 |
| 11 | 51.8 | 7.92 | 8.94 | 114.90 | 129.73 | 7.29 | 8.60 | 105.73 | 124.72 | 8.44 | 122.47 |
| 12 | 53.6 | 8.16 | 9.21 | 118.40 | 133.54 | 7.52 | 8.85 | 109.06 | 128.42 | 8.69 | 126.08 |
| 13 | 55.4 | 8.41 | 9.48 | 121.97 | 137.44 | 7.75 | 9.11 | 112.47 | 132.20 | 8.95 | 129.77 |
| 14 | 57.2 | 8.66 | 9.75 | 125.63 | 141.42 | 8.00 | 9.38 | 115.96 | 136.06 | 9.21 | 133.54 |
| 15 | 59 | 8.92 | 10.03 | 129.37 | 145.48 | 8.24 | 9.65 | 119.53 | 140.00 | 9.47 | 137.39 |
| 16 | 60.8 | 9.18 | 10.32 | 133.20 | 149.63 | 8.49 | 9.93 | 123.18 | 144.03 | 9.74 | 141.32 |
| 17 | 62.6 | 9.45 | 10.61 | 137.11 | 153.87 | 8.75 | 10.21 | 126.92 | 148.14 | 10.02 | 145.33 |
| 18 | 64.4 | 9.73 | 10.91 | 141.11 | 158.19 | 9.01 | 10.50 | 130.74 | 152.34 | 10.30 | 149.43 |
| 19 | 66.2 | 10.01 | 11.21 | 145.19 | 162.60 | 9.28 | 10.80 | 134.66 | 156.63 | 10.59 | 153.62 |
| 20 | 68 | 10.30 | 11.52 | 149.37 | 167.10 | 9.56 | 11.10 | 138.66 | 161.01 | 10.89 | 157.89 |
| 21 | 69.8 | 10.59 | 11.84 | 153.63 | 171.70 | 9.84 | 11.41 | 142.75 | 165.47 | 11.19 | 162.25 |
| 22 | 71.6 | 10.89 | 12.16 | 157.99 | 176.38 | 10.13 | 11.72 | 146.93 | 170.03 | 11.49 | 166.70 |
| 23 | 73.4 | 11.20 | 12.49 | 162.45 | 181.16 | 10.43 | 12.04 | 151.20 | 174.68 | 11.81 | 171.24 |
| 24 | 75.2 | 11.51 | 12.83 | 167.00 | 186.03 | 10.73 | 12.37 | 155.57 | 179.42 | 12.13 | 175.87 |
| 25 | 77 | 11.83 | 13.17 | 171.64 | 191.00 | 11.03 | 12.70 | 160.04 | 184.25 | 12.45 | 180.59 |
| 26 | 78.8 | 12.16 | 13.52 | 176.39 | 196.06 | 11.35 | 13.04 | 164.60 | 189.19 | 12.78 | 185.41 |
| 27 | 80.6 | 12.50 | 13.87 | 181.23 | 201.22 | 11.67 | 13.39 | 169.26 | 194.21 | 13.12 | 190.33 |
| 28 | 82.4 | 12.84 | 14.24 | 186.18 | 206.48 | 12.00 | 13.74 | 174.02 | 199.34 | 13.47 | 195.34 |
| 29 | 84.2 | 13.18 | 14.61 | 191.23 | 211.84 | 12.33 | 14.10 | 178.89 | 204.57 | 13.82 | 200.45 |
| 30 | 86 | 13.54 | 14.98 | 196.38 | 217.30 | 12.68 | 14.47 | 183.86 | 209.89 | 14.18 | 205.66 |
| 31 | 87.8 | 13.90 | 15.37 | 201.65 | 222.86 | 13.03 | 14.85 | 188.93 | 215.32 | 14.55 | 210.97 |
| 32 | 89.6 | 14.27 | 15.76 | 207.02 | 228.52 | 13.38 | 15.23 | 194.11 | 220.85 | 14.92 | 216.38 |
| 33 | 91.4 | 14.65 | 16.15 | 212.50 | 234.29 | 13.75 | 15.62 | 199.40 | 226.49 | 15.30 | 221.90 |
| 34 | 93.2 | 15.04 | 16.56 | 218.09 | 240.16 | 14.12 | 16.01 | 204.80 | 232.23 | 15.69 | 227.53 |
| 35 | 95 | 15.43 | 16.97 | 223.80 | 246.14 | 14.50 | 16.41 | 210.31 | 238.07 | 16.08 | 233.26 |
| 36 | 96.8 | 15.83 | 17.39 | 229.63 | 252.23 | 14.89 | 16.83 | 215.94 | 244.03 | 16.49 | 239.10 |

Guidelines for using R-452A and R-448A/R-449A in new and existing commercial refrigeration systems

| Temperature | | Pressure | | | | | | | | | |
|-------------|-------|--------------------|-----------------------|---------------------|------------------------|--------------------|-----------------------|---------------------|------------------------|--------------------|---------------------|
| °C | °F | R452A | | | | R448A/R449A | | | | R404A | |
| | | bar _{dew} | bar _{bubble} | psig _{dew} | psig _{bubble} | bar _{dew} | bar _{bubble} | psig _{dew} | psig _{bubble} | bar _{dew} | psig _{dew} |
| 37 | 98.6 | 16.24 | 17.82 | 235.57 | 258.43 | 15.28 | 17.24 | 221.68 | 250.09 | 16.90 | 245.05 |
| 38 | 100.4 | 16.66 | 18.25 | 241.63 | 264.73 | 15.69 | 17.67 | 227.53 | 256.27 | 17.31 | 251.11 |
| 39 | 102.2 | 17.09 | 18.70 | 247.82 | 271.15 | 16.10 | 18.10 | 233.51 | 262.55 | 17.74 | 257.29 |
| 40 | 104 | 17.52 | 19.15 | 254.13 | 277.68 | 16.52 | 18.54 | 239.61 | 268.95 | 18.17 | 263.58 |
| 41 | 105.8 | 17.97 | 19.60 | 260.56 | 284.32 | 16.95 | 18.99 | 245.83 | 275.47 | 18.62 | 270.00 |
| 42 | 107.6 | 18.42 | 20.07 | 267.13 | 291.08 | 17.39 | 19.45 | 252.18 | 282.09 | 19.07 | 276.53 |
| 43 | 109.4 | 18.88 | 20.54 | 273.82 | 297.95 | 17.83 | 19.91 | 258.65 | 288.84 | 19.52 | 283.18 |
| 44 | 111.2 | 19.35 | 21.02 | 280.65 | 304.94 | 18.29 | 20.39 | 265.25 | 295.71 | 19.99 | 289.95 |
| 45 | 113 | 19.83 | 21.51 | 287.62 | 312.04 | 18.75 | 20.87 | 271.98 | 302.69 | 20.47 | 296.85 |
| 46 | 114.8 | 20.32 | 22.01 | 294.72 | 319.27 | 19.23 | 21.36 | 278.85 | 309.79 | 20.95 | 303.88 |
| 47 | 116.6 | 20.82 | 22.52 | 301.97 | 326.62 | 19.71 | 21.86 | 285.85 | 317.02 | 21.44 | 311.03 |
| 48 | 118.4 | 21.33 | 23.03 | 309.35 | 334.08 | 20.20 | 22.36 | 292.98 | 324.37 | 21.95 | 318.32 |
| 49 | 120.2 | 21.85 | 23.56 | 316.89 | 341.67 | 20.70 | 22.88 | 300.26 | 331.85 | 22.46 | 325.74 |
| 50 | 122 | 22.38 | 24.09 | 324.57 | 349.39 | 21.21 | 23.40 | 307.67 | 339.45 | 22.98 | 333.29 |
| 51 | 123.8 | 22.92 | 24.63 | 332.40 | 357.23 | 21.73 | 23.94 | 315.23 | 347.19 | 23.51 | 340.98 |
| 52 | 125.6 | 23.47 | 25.18 | 340.39 | 365.19 | 22.27 | 24.48 | 322.94 | 355.05 | 24.05 | 348.82 |
| 53 | 127.4 | 24.03 | 25.74 | 348.54 | 373.28 | 22.81 | 25.03 | 330.79 | 363.04 | 24.60 | 356.79 |
| 54 | 129.2 | 24.60 | 26.30 | 356.84 | 381.50 | 23.36 | 25.59 | 338.79 | 371.16 | 25.16 | 364.91 |
| 55 | 131 | 25.19 | 26.88 | 365.31 | 389.85 | 23.92 | 26.16 | 346.95 | 379.42 | 25.73 | 373.18 |
| 56 | 132.8 | 25.78 | 27.46 | 373.95 | 398.34 | 24.49 | 26.74 | 355.26 | 387.82 | 26.31 | 381.60 |
| 57 | 134.6 | 26.39 | 28.06 | 382.75 | 406.95 | 25.08 | 27.33 | 363.72 | 396.35 | 26.90 | 390.17 |
| 58 | 136.4 | 27.01 | 28.66 | 391.73 | 415.70 | 25.67 | 27.92 | 372.35 | 405.02 | 27.50 | 398.90 |
| 59 | 138.2 | 27.64 | 29.27 | 400.89 | 424.58 | 26.28 | 28.53 | 381.14 | 413.83 | 28.12 | 407.79 |
| 60 | 140 | 28.28 | 29.90 | 410.22 | 433.59 | 26.90 | 29.15 | 390.09 | 422.78 | 28.74 | 416.83 |
| 61 | 141.8 | 28.94 | 30.53 | 419.74 | 442.75 | 27.52 | 29.78 | 399.21 | 431.87 | 29.37 | 426.05 |
| 62 | 143.6 | 29.61 | 31.17 | 429.45 | 452.04 | 28.17 | 30.41 | 408.51 | 441.11 | 30.02 | 435.43 |
| 63 | 145.4 | 30.29 | 31.82 | 439.36 | 461.47 | 28.82 | 31.06 | 417.97 | 450.50 | 30.68 | 444.98 |
| 64 | 147.2 | 30.99 | 32.48 | 449.45 | 471.04 | 29.48 | 31.72 | 427.61 | 460.03 | 31.35 | 454.70 |
| 65 | 149 | 31.70 | 33.15 | 459.75 | 480.76 | 30.16 | 32.39 | 437.43 | 469.72 | 32.03 | 464.61 |



Tecumseh

NORTH AMERICA
5 683 Hines Drive
Ann Arbor, MI 48108
USA
Tel +1 734 585 9500
Fax +1 734 352 3700

EUROPE
2, Avenue Blaise Pascal
38090 Vaulx Milieu
FRANCE
Tel +33 4 74 82 24 00
Fax +33 4 74 82 24 44
sales&marketing@tecumseh.
com

MALAYSIA
No. 18, Jalan Sultan Mohamed 4,
Selat Klang Utara,
42000 Port Klang,
Selangor Darul Ehsan
MALAYSIA
Tel +60 3 3176 3886
Fax +60 3 3176 3890

BRAZIL
Rua Ray Wesley Herrick,
700 São Carlos SP, 13565-090
BRAZIL
Tel +55 16 3362 3000
Fax +55 16 3363 7219

INDIA
Balanagar Industrial Township,
Hyderabad, 500 037
INDIA
Tel +91 40 30116993/94

CHINA
Tecumseh Compressor
(Guangzhou) Co., Ltd.
Room 634, Wuzi Building,
201 Guangbao Avenue,
Guangzhou Free Trade Zone,
CHINA
Code: 510730
Tel +86 20 8221 8072
Fax +86 20 8205 7456



Guidelines for using R449A and R452A
-EN-06/2016



Cooling for a Better Tomorrow

www.tecumseh.com