



Tecumseh

“Best in Class” Efficiency



AK² Series Compressor



ECO-FRIENDLY

AK² is optimized for use with eco-friendly refrigerant R290 (Propane), plus newly released U.S. EPA SNAP approved refrigerants R513A, R452A, R448A and R449A. Traditional refrigerants R134a and R404A are also supported by the AK².



PROVEN RELIABILITY

Leverages robust design attributes developed from decades of commercial refrigeration experience with this expansion and update of the AK product family including larger bearing surfaces.



PERFORMANCE

New valve plate, muffler and motor designs result in improved compressor efficiency.



LOW NOISE

New suction muffler and internal suspension system as well as a new rounded housing combine to deliver significant improvements in sound quality.



SERVICE AND SUPPORT

Backed by Tecumseh's network of knowledgeable applications engineers, test labs and support personnel.

AK² SERIES COMPRESSOR NOMENCLATURE

AK 4 482 U-XA 3B

Compressor Series

Application Code

2 LBP
4 H/CBP

Rating Point (Evaporating Temperature)

LBP -10°F (-23.3°C)
CBP +20°F (-6.7°C)
HBP +45°F (+7.2°C)

Capacity (Btu/h)

First digit represents the number of digits in BTU capacity at ASHRAE conditions.

Last two digits represent the first two digits in the Rated Btu/h capacity. In this example, four (4) total digits with the first two (82) or 8,200 Btu/h capacity.

Capacitor Options

First Character (Run Capacitor)

- 1 Without Run Capacitor
- 2 Optional Run Capacitor
- 3 With Run Capacitor

Voltage Code

AA 115/60/1
XA 115/60/1
100/50/1
XD 208-230/60/1
200/50/1
XN 208-230/60/1
200-220/50/1
NA 208-230/60/1
FZ 220-240/50/1

Refrigerant Type

U R290
Y R134a/R513A
Z R404A/R452A/
R448A/R449A

AK² SERIES COMPRESSOR INFORMATION

Application	ASHRAE / AHRI	ASHRAE / AHRI	ASHRAE / AHRI	ASHRAE / AHRI	ASHRAE / AHRI
	R290	R134a / R513A	R404A	R452A	R449A
HBP	8,250-14,350 7,850-13,750	6,150-10,350 5,850-9,850	9,850-16,250 8,800-14,950	9,850-15,550 9,100-14,850	9,800-16,250 9,150-15,250
CBP	4,200-7,950 4,000-6,950	3,100-5,350 3,000-5,000	5,400-8,700 4,850-7,800	5,350-8,300 4,800-7,450	5,400-8,600 4,850-7,700
LBP	2,500-4,650 2,000-3,800	N/A	2,700-4,900 2,100-3,600	2,450-4,450 2,000-3,400	N/A

AK² SERIES COMPRESSOR DIMENSIONS

Housing	A - Width (IN)	B - Height (IN)	C - Length (IN)	D - Bracket (IN)	E - Bracket (IN)
DCAK100/102	7.222" - 7.402"	8.597" - 8.722"	9.145" - 9.325"	7.969" - 8.031"	4.780" - 4.820"
DCAK101/103	7.222" - 7.402"	9.148" - 9.273"	9.145" - 9.325"	7.969" - 8.031"	4.780" - 4.820"

Copper Connection Sizes (IN)	
Process Tube	3/8" OD / 1/4" ID
Suction Tube	1/2" OD / 3/8" ID
Discharge Tube	3/8" OD / 1/4" ID

Left Side View

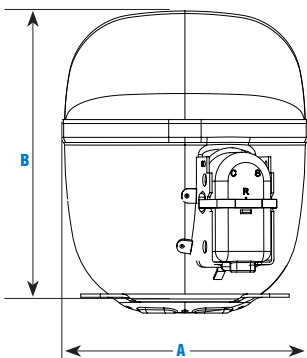

Right Side View

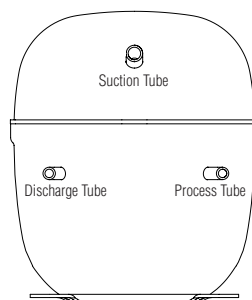

Top View

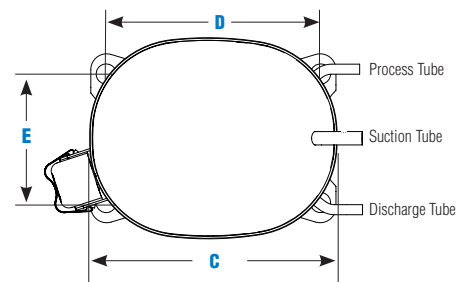

PERFORMANCE SPECIFICATION H/CBP

HBP/CBP 5°F to +59°F or (-15°C to +15°C)

Model	Voltage	Disp (Cu In)	Refrig.	ASHRAE								AHRI								EN12900	
				45°F (7.2°C)				20°F (-6.7°C)				45°F (7.2°C)				20°F (-6.7°C)				41°F (5°C)	
				Capacity		Efficiency		Capacity		Efficiency		Capacity		Efficiency		Capacity		Efficiency		Capacity	Efficiency
				BTU/Hr	Watts	EER	COP	BTU/Hr	Watts	EER	COP	BTU/Hr	Watts	EER	COP	BTU/Hr	Watts	EER	COP	Watts	COP

R134a / R513A

AK4461Y-XA3B	115/60/1 100/50/1	0.954	R134a/ R513A	6,145	1,799	9.13	2.67	3,077	901	6.20	1.82	5,844	1,711	8.72	2.55	2,983	873	6.00	1.76		
AK4461Y-FZ3B	220-240/50/1	0.954	R134a/ R513A	5,440	1,593	10.28	3.01	2,619	767	6.80	1.99	5,090	1,490	9.71	2.84	2,511	735	6.50	1.90	1,372	2.80
AK4468Y-XA3B	115/60/1 100/50/1	1.065	R134a/ R513A	6,750	1,976	9.15	2.68	3,500	1,025	6.50	1.90	6,500	1,903	8.70	2.55	3,221	943	5.80	1.70		
AK4481Y-XA3B	115/60/1 100/50/1	1.247	R134a/ R513A	8,172	2,393	8.80	2.58	4,393	1,286	6.40	1.87	7,624	2,232	8.60	2.52	4,136	1,211	6.50	1.90		
AK4481Y-FZ3B	220-240/50/1	1.247	R134a/ R513A	6,814	1,995	9.60	2.81	3,804	1,114	7.10	2.08	6,471	1,895	9.15	2.68	3,401	996	6.20	1.82	1,712	2.50
AK4481Y-XD3B	208-230/60/1 200/50/1	1.247	R134a/ R513A	8,173	2,393	9.37	2.74	4,460	1,306	6.50	1.90	7,677	2,248	8.38	2.45	3,890	1,139	5.80	1.70		
AK4510Y-XA3B	115/60/1 100/50/1	1.567	R134a/ R513A	10,371	3,037	8.91	2.61	5,330	1,561	5.91	1.73	9,830	2,878	8.41	2.46	5,018	1,469	6.00	1.76		
AK4510Y-NA3B	208-230/60/1	1.567	R134a/ R513A	10,304	3,017	9.08	2.66	4,900	1,435	5.90	1.73	9,669	2,831	8.50	2.49	4,865	1,425	5.90	1.73		

R404A/R452A/R448A/R449A

AK4510Z-XA3B	115/60/1 100/50/1	0.954	R404A	9,871	2,890	8.55	2.50	5,389	1,578	5.60	1.64	8,812	2,580	7.41	2.17	4,839	1,417	5.30	1.55		
			R452A	9,841	2,882	8.75	2.56	5,365	1,571	5.95	1.74	9,094	2,663	8.10	2.37	4,818	1,411	5.63	1.65		
			R448A/R449A	9,776	2,863	9.22	2.70	5,412	1,585	6.42	1.88	9,162	2,683	8.65	2.53	4,860	1,423	6.08	1.78		
AK4510Z-FZ3B	220-240/50/1	0.954	R404A	8,244	2,414	9.30	2.72	4,814	1,410	6.55	1.92	7,513	2,200	8.47	2.48	4,323	1,266	6.20	1.82	1,946	2.50
			R452A	8,339	2,442	9.74	2.85	4,488	1,314	6.33	1.85	7,623	2,232	8.89	2.60	4,030	1,180	5.99	1.75	2,042	2.50
			R448A/R449A	8,191	2,399	10.00	2.93	4,466	1,308	6.66	1.95	7,693	2,253	9.36	2.74	4,011	1,174	6.30	1.84	2,310	3.10
AK4510Z-NA3C	208-230/60/1	0.954	R404A	10,073	2,949	9.35	2.74	6,198	1,815	7.08	2.07	9,280	2,717	8.50	2.49	5,565	1,629	6.70	1.96		
			R452A	9,947	2,913	9.45	2.77	5,357	1,569	6.29	1.84	9,240	2,706	8.75	2.56	4,811	1,409	5.95	1.74		
			R448A/R449A	9,872	2,890	9.91	2.90	5,581	1,634	6.97	2.04	9,323	2,730	9.31	2.73	5,011	1,467	6.60	1.93		
AK4511Z-XA3B	115/60/1 100/50/1	1.065	R404A	10,581	3,098	8.38	2.45	5,861	1,716	5.60	1.64	9,755	2,856	7.74	2.27	5,263	1,541	5.30	1.55		
			R452A	10,316	3,020	8.52	2.49	5,402	1,582	5.77	1.69	10,333	3,026	7.99	2.34	4,851	1,420	5.46	1.60		
			R448A/R449A	10,245	3,000	8.88	2.60	5,574	1,632	6.27	1.83	9,590	2,808	8.30	2.43	5,005	1,466	5.93	1.74		
AK4511Z-XD3B	208-230/60/1 200/50/1	1.065	R404A	11,323	3,315	8.85	2.59	6,017	1,762	5.71	1.67	10,467	3,065	8.18	2.40	5,403	1,582	5.40	1.58		
			R452A	11,123	3,257	9.01	2.64	5,922	1,734	5.91	1.73	10,306	3,018	8.36	2.45	5,318	1,557	5.59	1.64		
			R448A/R449A	10,916	3,196	9.21	2.70	5,948	1,742	6.23	1.83	10,447	3,059	8.81	2.58	5,341	1,564	5.90	1.73		
AK4513Z-XA3B	115/60/1 100/50/1	1.247	R404A	12,914	3,781	8.13	2.38	6,837	2,002	5.39	1.58	11,851	3,470	7.51	2.20	6,139	1,798	5.10	1.49		
			R452A	12,701	3,719	8.31	2.43	6,950	2,035	6.05	1.77	11,829	3,464	7.76	2.27	6,241	1,827	5.73	1.68		
			R448A/R449A	12,385	3,626	8.49	2.49	6,950	2,035	6.05	1.77	12,047	3,527	8.30	2.43	6,241	1,827	5.73	1.68		
AK4513Z-FZ3B	220-240/50/1	1.247	R404A	10,882	3,186	8.88	2.60	6,058	1,774	6.13	1.79	10,063	2,947	8.23	2.41	5,440	1,593	5.80	1.70	2,715	2.40
			R452A	10,895	3,190	9.16	2.68	5,955	1,744	6.16	1.80	10,090	2,954	8.44	2.47	5,347	1,566	5.83	1.71	2,689	2.44
			R448A/R449A	10,726	3,141	9.49	2.78	6,172	1,807	6.75	1.98	10,226	2,994	9.00	2.64	5,542	1,623	6.39	1.87	2,725	2.60
AK4513Z-XD3B	208-230/60/1 200/50/1	1.247	R404A	12,731	3,728	8.23	2.41	6,706	1,964	5.39	1.58	11,687	3,422	7.67	2.25	6,022	1,763	5.10	1.49		
			R452A	11,968	3,504	8.10	2.37	6,846	2,004	5.75	1.68	11,720	3,432	7.90	2.31	6,147	1,800	5.44	1.59		
			R448A/R449A	11,191	3,277	7.95	2.33	6,815	1,996	5.49	1.61	10,615	3,108	7.60	2.23	6,120	1,792	5.20	1.52		
AK4513Z-NA3C	208-230/60/1	1.247	R404A	13,071	3,827	8.70	2.55	7,430	2,176	6.02	1.76	12,045	3,527	7.92	2.32	6,672	1,954	5.70	1.67		
			R452A	13,120	3,842	9.02	2.64	7,148	2,093	6.11	1.79	12,201	3,573	8.39	2.46	6,419	1,879	5.78	1.69		
			R448A/R449A	13,234	3,875	9.02	2.64	7,272	2,129	6.60	1.93	12,266	3,592	8.86	2.59	6,530	1,912	6.25	1.83		
AK4516Z-NA3C	208-230/60/1	1.567	R404A	16,246	4,757	8.28	2.42	8,687	2,544	5.49	1.61	14,973	4,384	7.59	2.22	7,800	2,284	5.20	1.52		
			R452A	15,570	4,559	8.51	2.49	8,313	2,434	5.72	1.67	14,873	4,355	7.86	2.30	7,465	2,186	5.41	1.58		
			R448A/R449A	16,251	4,464	8.74	2.56	8,587	2,514	6.17	1.81	15,244	4,464	8.45	2.47	7,710	2,258	5.84	1.71		

R290

AK4482U-XA3B	115/60/1 100/50/1	0.954	R290	8,238	2,412	9.80	2.87	4,203	1,231	6.54	1.91	7,834	2,294	9.34	2.73	3,991	1,169	6.20	1.82		
AK4482U-FZ3B	220-240/50/1	0.954	R290	6,904	2,022	10.55	3.09	3,930	1,151	7.70	2.25	6,487	1,899	9.87	2.89	3,203	938	6.50	1.90	1,731	2.90
AK4482U-XD3B	208-230/60/1 200/50/1	0.954	R290	8,410	2,463	10.45	3.06	4,632	1,356	7.00	2.05	7,995	2,341	9.90	2.90	4,213	1,234	6.50	1.90		
AK4492U-XA3B	115/60/1 100/50/1	1.065	R290	9,167	2,684	9.60	2.81	5,050	1,479	6.46	1.89	8,591	2,516	9.17	2.68	4,490	1,315	6.30	1.84		
AK4492U-XN3B	208-230/60/1 200-220/50/1	1.065	R290	9,362	2,741	10.42	3.05	4,939	1,446	7.00	2.05	8,883	2,601	9.88	2.89	4,663	1,365	6.66	1.95		
AK4511U-XA3B	115/60/1 100/50/1	1.247	R290	11,028	3,229	9.05	2.65	6,406	1,876	6.40	1.87	10,558	3,091	8.70	2.55	5,791	1,696	6.10	1.79		
AK4514U-NA3B	208-230/60/1	1.567	R290	14,363	4,206	9.66	2.83	7,940	2,325	6.90	2.02	13,731	4,020	9.26	2.71	6,950	2,035	6.20	1.82		

PERFORMANCE SPECIFICATION LBP

LBP -40°F to +10°F or (-40°C to -12°C)

Model	Voltage	Disp (Cu In)	Refrig.	ASHRAE				AHRI				EN12900	
				-10°F (-23.3°C)				-10°F (-23.3°C)				-31°F (-35°C)	
				Capacity		Efficiency		Capacity		Efficiency		Capacity	Efficiency
				BTU/Hr	Watts	EER	COP	BTU/Hr	Watts	EER	COP	Watts	COP

R404A / R452A

AK2427Z-FZ3B	220-240/50/1	0.954	R404A	1,906	558	4.50	1.32	1,462	428	3.33	0.98	243	0.90
			R452A	1,811	530	4.40	1.29	1,389	407	3.30	0.97	184	0.80
AK2427Z-NA3B	208-230/60/1	0.954	R404A	2,697	790	4.60	1.35	2,081	609	3.51	1.03		
			R452A	2,468	723	4.47	1.31	1,980	580	3.52	1.03		
AK2430Z-XA3B	115/60/1 100/50/1	1.065	R404A	3,007	880	4.63	1.36	2,321	680	3.50	1.02		
			R452A	2,920	855	4.78	1.40	2,257	661	3.62	1.06		
AK2430Z-FZ3B	220-240/50/1	1.065	R404A	2,500	732	4.63	1.36	1,828	535	3.54	1.04	339	1.00
			R452A	2,191	642	4.54	1.33	1,728	506	3.58	1.05	307	0.90
AK2430Z-XD3B	208-230/60/1 200/50/1	1.065	R404A	2,930	858	4.41	1.29	2,327	681	3.39	0.99		
			R452A	2,488	729	4.24	1.24	2,197	643	3.60	1.05		
AK2436Z-AA3B	115/60/1	1.247	R404A	3,650	1,069	4.68	1.37	2,887	845	3.60	1.05		
			R452A	2,975	871	4.50	1.32	2,523	739	3.82	1.12		
AK2436Z-FZ3B	220-240/50/1	1.247	R404A	3,121	914	4.70	1.38	2,248	658	3.43	1.00	454	1.00
			R452A	2,797	819	4.47	1.31	2,287	670	3.67	1.07	443	1.00
AK2448Z-AA3C	115/60/1	1.567	R404A	4,780	1,400	4.80	1.41	3,493	1,023	3.50	1.02		
			R452A	4,444	1,301	4.73	1.38	3,403	996	3.67	1.07		
AK2448Z-FZ3C	220-240/50/1	1.567	R404A	4,130	1,209	5.10	1.49	3,057	895	3.80	1.11	612	1.10
			R452A	3,676	1,076	4.96	1.45	2,865	839	3.90	1.14	556	1.10
AK2448Z-NA3C	208-230/60/1	1.567	R404A	4,892	1,432	4.70	1.38	3,587	1,050	3.50	1.02		
			R452A	4,454	1,304	4.29	1.26	3,412	999	3.30	0.97		

R290

AK2424U-XA3B	115/60/1 100/50/1	1.065	R290	2,500	732	4.71	1.38	2,024	593	3.94	1.15		
AK2431U-XA3B	115/60/1 100/50/1	1.247	R290	3,132	917	5.00	1.46	2,587	758	4.21	1.23		
AK2431U-FZ3B	220-240/50/1	1.247	R290	2,498	731	4.90	1.43	1,995	584	3.98	1.17	387	1.10
AK2431U-XN3B	208-230/60/1 200-220/50/1	1.247	R290	3,166	927	5.10	1.49	2,628	770	4.23	1.24		
AK2447U-AA3C	115/60/1	1.567	R290	4,651	1,362	5.30	1.55	3,804	1,114	4.40	1.29		
AK2447U-NA3C	208-230/60/1	1.567	R290	4,539	1,329	5.30	1.55	3,690	1,080	4.40	1.29		

Refrigerant(s):

R290, R134a, R513A, R404A, R452A, R448A, R449A

Application(s):

H/CBP: +5°F to +59°F (-15°C to +15°C)

LBP: -40°F to +10°F (-40°C to -12°C)

Lubricant(s): POE 32 cSt

Key Features:

- Optimized for eco-friendly R290 (Propane) refrigerant and designed for use with U.S. EPA SNAP approved refrigerants.
- Highly reliable, designed to meet the rigors of commercial refrigeration
- Expanded H/CBP evaporating temperature range
- Energy efficient, quiet operation
- Significant improvements of AK² vs. AK series compressor:
 - Up to 25% more efficient | 8 to 10 dBA reduction in sound power
- Solid copper tube connections